

Data Sheet

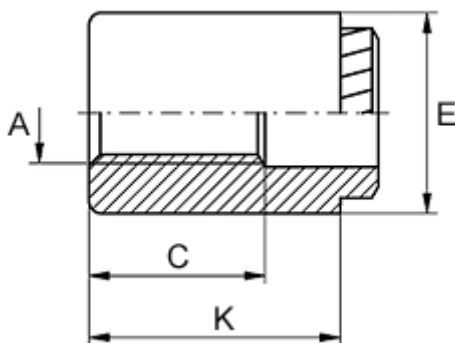

Article number: 12511600020100
Description: KLEE-coil 511 600 020.100
M2 Hardened, zinc-pl.

Measures



Female thread A	= M2
Height K	= 11
Hole diameter +0.1	= 3.7
Min distance to edge	= 2.2
Min material thickness	= 1.5
Outer diameter E	= 6
Thread length	= 9